

Highly dynamic
or extremely compact –
the new 1FK7
servomotors

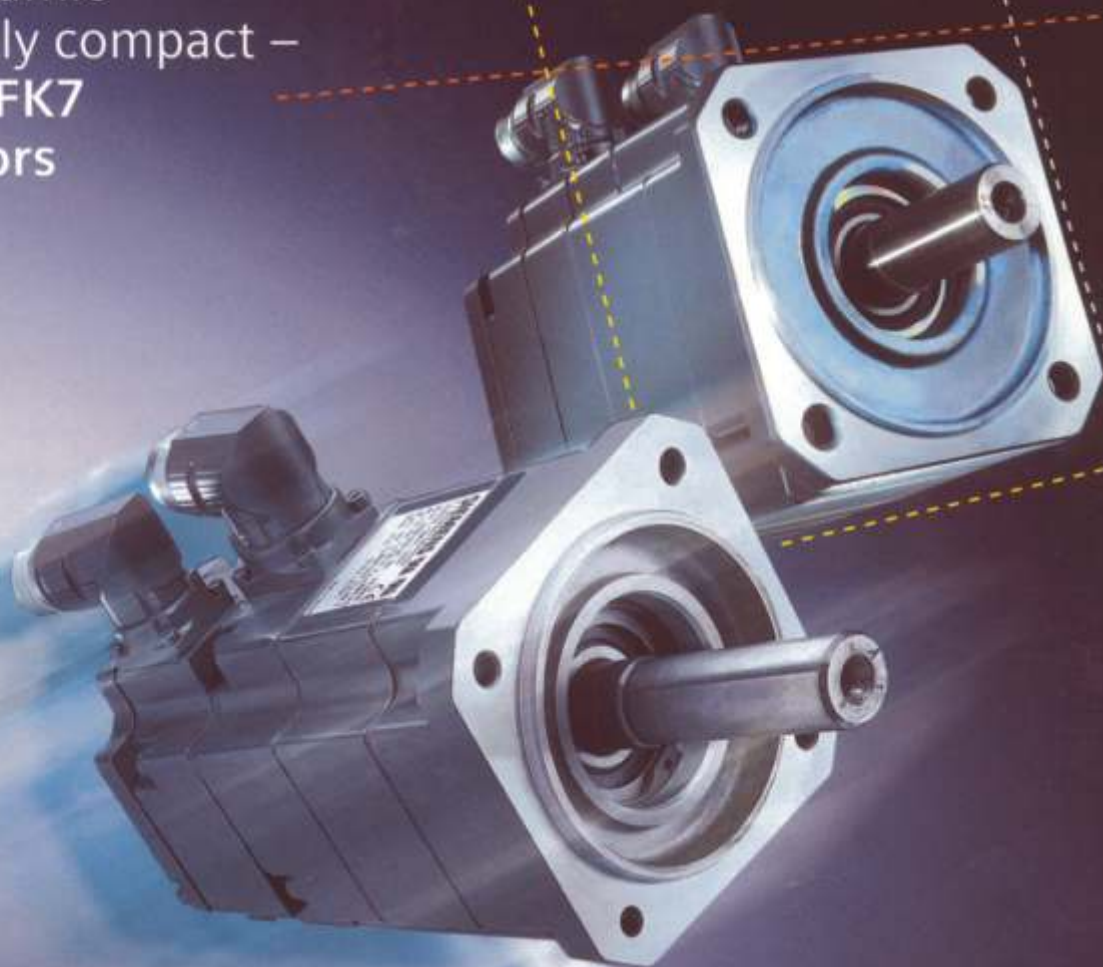

servomotor

1FK7

SIEMENS

1FK7 servomotors: The new standard for Motion Control tasks

Motion Control controls motion sequences in many machines and in the widest range of industry segments. Today, 1FK6 synchronous servomotors dominate drive systems which involve complex sequences such as closed-loop position and speed controls. However, we have further improved this well-proven technology. With the leading edge 1FK7 servomotors, based on the successful 1FK6 series, a new servo standard has been created which has significantly improved the benchmark in essential areas. With significantly higher dynamic performance, compactness and degree of system integration, this new generation of motors will fulfill all of the future market requirements. Not only this, its flexibility will address your specific demands.

Individual solutions

No matter what your requirements are, the new 1FK7 servomotors will always provide you with the perfect drive system solution. Now, the features of the motors can be individually adapted to your drive tasks even more so than before. This is ensured by two motor versions whose strengths can be fully leveraged and which are also compatible to the Siemens SIMOVERT MASTERDRIVES® MC and SIMODRIVE® drive converter systems. The result – an optimally harmonized technical and cost-effective solution.

Dynamic performance for the highest possible process optimization

The 1FK7 HD version stands for High Dynamic – allowing for extreme load duty cycles, short rise times as well as high accuracy when it comes to speed, torque and position. This is guaranteed by a

high overload capability, low intrinsic moment of inertia and a rugged mechanical design. This allows you to significantly improve your closed-loop control and at the same time establish new cost-saving potentials.

Compact – for every application

High power density in the smallest package – these are the strengths of the 1FK7 CT Compact Version. It has a square design, uses innovative technology and the further development of integrated system components means that these motors take up approximately 25% less space than their 1FK6 predecessors. These are decisive factors which make the new 1FK7 CT a universal servomotor.

Whether dynamic or compact – the 1FK7 is always the optimum solution

Flexible using a modular principle
Higher output and lower weight, these

are the distinguishing factors of the active and frameless stator of the 1FK7. The power loss is effectively and simply dissipated using natural cooling. Various encoder systems as well as a holding brake can be integrated depending on the specific task. The motor components can be selected to match the actual requirements thus guaranteeing the most compact design. Power and encoders are connected using leading-edge connector systems and the cable outlet direction can be freely rotated.

Rugged design for extreme conditions

The 1FK7 is fully equipped for applications in rugged industrial environments. High degree of protection, rugged bearing design and vibration-free performance mean that the new servomotors are the ideal motor solution when conditions are demanding. Additionally, integrated temperature sensors protect the winding insulation from reaching dangerous operating conditions.

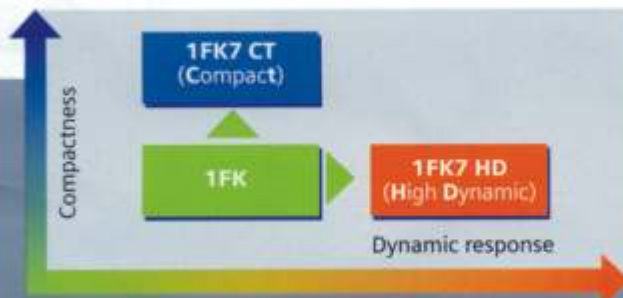

Fit for all requirements

No matter what your requirements are, high standstill torques and maximum speeds as well as excellent smooth-running properties of the 1FK7 servomotors guarantee the highest quality. Thanks to the different versions regarding dynamic performance and compactness, you can optimally adapt the system to your specific requirements.

High efficiency with low operating costs

Siemens permanent-magnet synchronous servomotors use the newest magnetic technique and have the highest efficiencies in comparison to conventional three-phase motors. The permanent magnet excitation means that 1FK7 variable-speed motors have no excitation losses. Furthermore, efficiencies of up to 94% guarantee the lowest energy consumption. This means, in addition to significant energy saving, you can drastically reduce your operating costs.

Compatible and easy to integrate

This motor system has wide-ranging benefits as it can be simply integrated into systems with all of the components operating harmoniously with one another.

The 1FK7 servomotors are absolutely compatible with the drive converters – one of the essential features. This means that, in conjunction with our intelligent, modular SIMODRIVE and SIMOVERT MASTERDRIVES Motion Control AC drives, the new 1FK7 servomotors can fully utilize their performance. In daily operation in the field, our motors can be easily commissioned, have excellent control properties and provide the highest degree of dynamic response for your process.

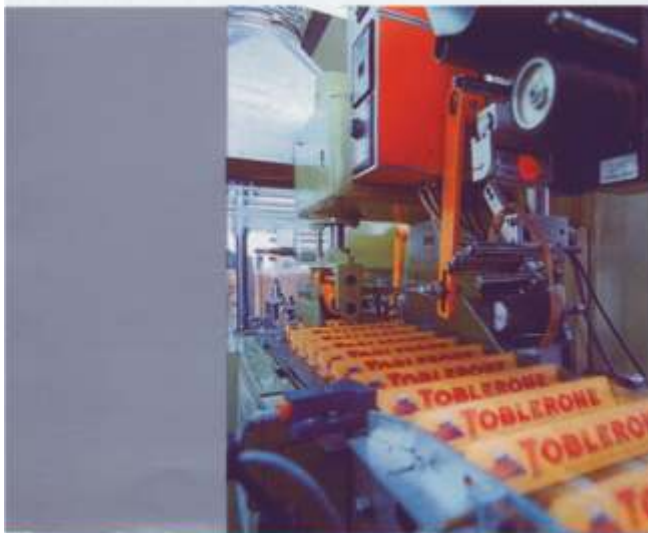



1FK7 HD (High Dynamic): High dynamic response

Leading-edge response

Dynamic response in your process means increased production. In this case, motor acceleration is the name of the game. The new 1FK7 HD servomotors provide the necessary performance for these requirements – supplying impressive response. Our new sprinter exceeds all expectations. In conjunction with the high stall torques, they have an extremely high acceleration capability and an extremely low intrinsic moment of inertia. Even the optional holding brake has been designed with a low moment of inertia.

Extreme load duty cycles, fast positioning and equally fast stopping can be realized in the shortest time thanks to these characteristics. We have completely redeveloped the rotors of our servomotors and consequently built the 1FK7 HD for high dynamic response. The HD version is available in 4 shaft heights and 11 different versions. This makes your machine of today fit for the tasks of tomorrow.

MOTION CONNECT for reliable connections

In order that your process is always in production, the 1FK7 servomotors can be reliably and safely connected to our SIMODRIVE or SIMOVERT MASTERDRIVES Motion Control AC drive converters using the new MOTION CONNECT® system. This is a connection system where you can find the optimum preassembled power and signal cables for every application. Not only this, you can save time and money as a result of the simple installation. High immunity to vibration, optimum electromagnetic compatibility and three performance level selections further guarantees maximum reliability.



SH 36



SH 48



SH 63





SH 80

The performance and system integration capability of our 1FK7 motors can be fully utilized when used with SIMODRIVE or MASTERDRIVES Motion Control.



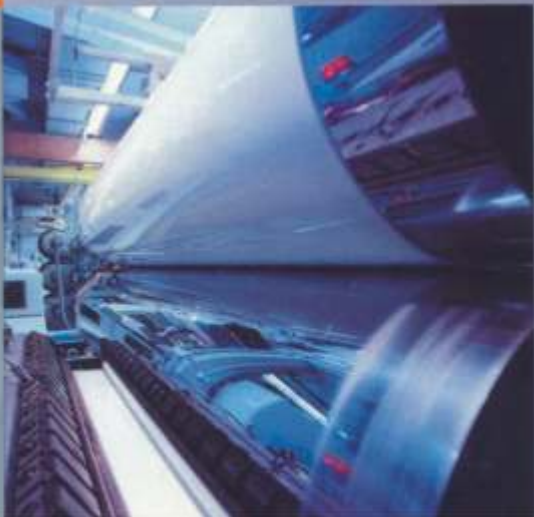
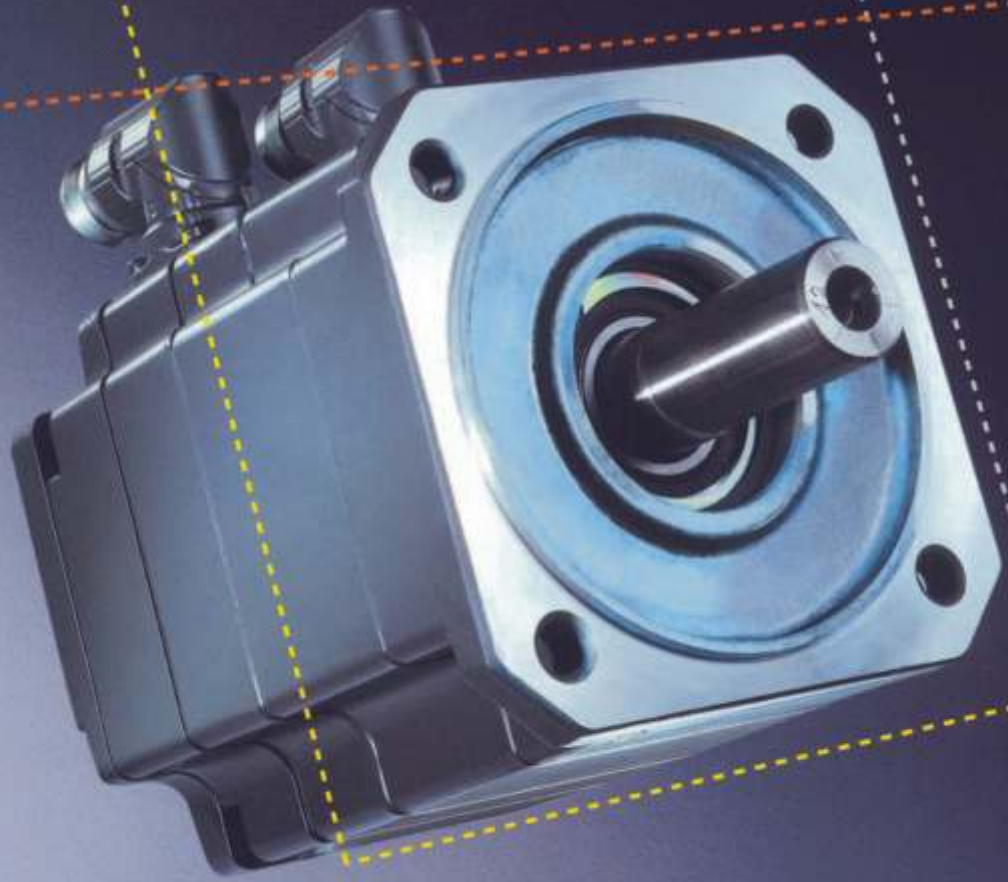

1FK7 CT (Compact): Universal for every application

The most compact of its class

When space is limited, only the most compact motor has a chance. The "lean" 1FK7 CT servomotors with their flexible and modular design are some of the most compact of their class thanks to their small dimensions. Maximum drive power can be provided in the tightest spaces in any machine as a result of the high power density and the square design. For instance, our smallest version, with shaft height 28, produces 0.85 Nm (7.5 lb_f-in) of torque and comes with an edge to edge length of only 55 mm (2.1 in). The CT version is available in 6 shaft heights and 16 versions.

An interesting bottom line

Our motto is tailored performance. This means that you always obtain the best, most favorably-priced solution for your requirements – and you only pay for what you actually require. The flexible selection over the complete range of outputs and options allows the motor to be universally used. You can select a speed range from 3000 up to 6000 RPM and torques from 0.85 to 36 Nm (7.5 to 318 lb_f-in). Thus allowing

you to fully utilize the performance of the machine and drive – performance on demand.

Flexible for all requirements

A broad range of encoder systems guarantees the demanded motor performance. Using the well-proven resolver systems, almost all motion tasks, ranging from basic up to medium complexity, can be handled. When it comes to higher requirements, you can select between the high-precision sin/cos encoders and the absolute-value encoders, mainly used for positioning tasks. Alternatively, you can order the motor with mounted gearbox. Versions can be selected from helical, beveled, offset or worm gearboxes here. Because the gearbox is mounted directly to the motor, the envelope dimensions are reduced to the absolute necessary. Planetary gearboxes are the best selection when precise positioning is required. And, furthermore, we can provide the motor in the paint finish that you desire.



SH 28



SH 36



SH 48

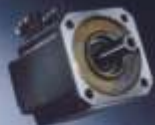

SH 63



SH 80



AH 100



Motor data 1FK7 HD

Drive converter data

1FK7 servomotors, non-ventilated	Rated speed	Max. continuous output	Rated torque	Stall torque	Stall current	Moment of inertia without brake	Weight without brake	Rated current	SIMOVERT MASTERDRIVES Motion Control drive converter	Rated current	SIMODRIVE 611 drive power module
Order No.	n_n rpm	P_n kW (HP)	M_n Nm (lb _f -in)	M_s Nm (lb _f -in)	I_s A	J kgcm ² (x10 ⁻³ lb _f -in ²)	m kg (lb)	I_{un} A	Order No.	I_{un} A	Order No.
1FK7044-7AF71-1...	3000	1.1 (1.5)	3.5 (31.0)	4.0 (35.4)	4.5	1.28 (1.13)	7.7 (16.9)	6.1	6SE7016-0TP50	5	6SN112-1AA00-0AA1
1FK7061-7AF71-1...		1.7 (2.3)	5.4 (47.8)	6.4 (56.6)	6.1	3.4 (3.0)	10.0 (22)	6.1	6SE7016-0TP50	9	6SN112-1AA00-0BA1
1FK7064-7AF71-1...		2.51 (3.37)	8.0 (70.8)	12.0 (106.2)	11	6.5 (5.8)	15.5 (34.1)	13.2	6SE7021-3TP50	18	6SN112-1AA00-0CA1
1FK7082-7AF71-1...		2.51 (3.37)	8.0 (70.8)	14.0 (123.9)	10.6	14.0 (12.4)	17.2 (37.9)	13.2	6SE7021-3TP50	18	6SN112-1AA00-0CA1
1FK7085-7AF71-1...	2500	3.14 (4.21)	12.0 (106.2)	22.0 (194.7)	22.5	23.0 (20.4)	23.5 (51.8)	25.5	6SE7022-6TP50	28	6SN112-1AA00-0DA1
1FK7043-7AH71-1...	4500	1.23 (1.65)	2.6 (23.0)	3.1 (27.4)	4.5	1.01 (0.89)	6.3 (13.9)	6.1	6SE7016-0TP50	5	6SN112-1AA00-0AA1
1FK7044-7AH71-1...		1.41 (1.89)	3.0 (26.6)	4.0 (35.4)	6.3	1.28 (1.13)	7.7 (16.9)	10.2	6SE7021-0TP50	9	6SN112-1AA00-0BA1
1FK7061-7AH71-1...		2.03 (2.72)	4.3 (38.1)	6.4 (56.6)	8	3.4 (3.0)	10.0 (22)	10.2	6SE7021-0TP50	9	6SN112-1AA00-0BA1
1FK7064-7AH71-1...		2.36 (3.16)	5.0 (44.3)	12.0 (106.2)	15	6.5 (5.8)	15.5 (34.1)	17.5	6SE7021-8TP50	18	6SN112-1AA00-0CA1
1FK7033-7AK71-1...	6000	0.57 (0.76)	0.9 (8.0)	1.3 (11.5)	2.2	0.27 (0.24)	3.10 (6.8)	4	6SE7014-0TP50	3	6SN112-1AA00-0HA1
1FK7043-7AK71-1...		1.26 (1.69)	2.0 (17.7)	3.1 (27.4)	6.4	1.01 (0.89)	6.3 (13.9)	10.2	6SE7021-0TP50	9	6SN112-1AA00-0BA1

Motor data 1FK7 CT

Drive converter data

1FK7 servomotors, non-ventilated	Rated speed	Max. continuous output	Rated torque	Stall torque	Stall current	Moment of inertia without brake	Weight without brake	Rated current	SIMOVERT MASTERDRIVES Motion Control drive converter	Rated current	SIMODRIVE 611 drive power module
Order No.	n_n rpm	P_n kW (HP)	M_n Nm (lb _f -in)	M_s Nm (lb _f -in)	I_s A	J kgcm ² (x10 ⁻³ lb _f -in ²)	m kg (lb)	I_{un} A	Order No.	I_{un} A	Order No.
1FK7042-5AF71-1...	3000	0.82 (1.10)	2.6 (23.0)	3.0 (26.6)	2.2	3.01 (2.66)	4.9 (10.8)	4	6SE7014-0TP50	3	6SN112-1AA00-0HA1
1FK7060-5AF71-1...		1.48 (1.98)	4.7 (41.6)	6.0 (53.1)	4.5	7.95 (7.04)	7.0 (15.4)	6.1	6SE7016-0TP50	5	6SN112-1AA00-0AA1
1FK7063-5AF71-1...		2.29 (3.07)	7.3 (64.6)	11.0 (97.4)	8	15.1 (13.4)	11.5 (25.3)	10.2	6SE7021-0TP50	9	6SN112-1AA00-0BA1
1FK7080-5AF71-1...		2.14 (2.87)	6.8 (60.2)	8.0 (70.8)	4.8	15.0 (13.3)	10 (22)	6.1	6SE7016-0TP50	5	6SN112-1AA00-0AA1
1FK7083-5AF71-1...		3.3 (4.4)	10.5 (92.9)	16.0 (141.6)	10.4	27.3 (24.2)	14 (30.8)	13.2	6SE7021-3TP50	18	6SN112-1AA00-0CA1
1FK7100-5AF71-1...		3.77 (5.06)	12.0 (106.2)	18.0 (159.3)	11.2	55.3 (48.9)	19 (41.8)	13.2	6SE7021-3EB51	18	6SN112-1AA00-0CA1
1FK7101-5AF71-1...		4.87 (6.53)	15.5 (137.2)	27.0 (239.0)	19	79.9 (70.7)	21.0 (46.2)	25.5	6SE7022-6TP50	18	6SN112-1AA00-0CA1
1FK7103-5AF71-1...	2500	5.37 (7.20)	20.5 (181.4)	36.0 (318.6)	27.5	105.0 (92.9)	29 (63.8)	34	6SE7023-4TP50	28	6SN112-1AA00-0DA1
1FK7060-5AH71-1...	4500	1.74 (2.33)	3.7 (32.7)	6.0 (53.1)	6.2	7.95 (7.04)	7 (15.4)	6.1	6SE7016-0TP50	9	6SN112-1AA00-0BA1
1FK7063-5AH71-1...	4000	2.09 (2.80)	5.0 (44.3)	11.0 (97.4)	12	15.1 (13.4)	11.5 (25.3)	13.2	6SE7021-3TP50	18	6SN112-1AA00-0CA1
1FK7080-5AH71-1...	4000	2.38 (3.19)	5.7 (50.4)	8.0 (70.8)	7.4	15.0 (13.3)	10 (22)	10.2	6SE7021-0TP50	9	6SN112-1AA00-0BA1
1FK7083-5AH71-1...	3500	3.04 (4.08)	8.3 (73.5)	16.0 (141.6)	15	27.3 (24.2)	14 (30.8)	17.5	6SE7021-8TP50	18	6SN112-1AA00-0CA1
1FK7022-5AK71-1...	6000	0.4 (0.5)	0.63 (5.58)	0.85 (7.52)	1.8	0.28 (0.25)	1.8 (4.0)	2	6SE7012-0TP50	3	6SN112-1AA00-0HA1
1FK7032-5AK71-1...		0.47 (0.6)	0.75 (6.64)	1.1 (9.7)	1.7	0.61 (0.54)	2.7 (5.9)	2	6SE7012-0TP50	3	6SN112-1AA00-0HA1
1FK7040-5AK71-1...		0.69 (0.93)	1.1 (9.7)	1.6 (14.2)	2.25	1.69 (1.50)	3.5 (7.7)	4	6SE7014-0TP50	3	6SN112-1AA00-0HA1
1FK7042-5AK71-1...	5000	1.02 (1.37)	2.0 (17.7)	3.0 (26.6)	4.4	3.01 (2.66)	4.9 (10.8)	6.1	6SE7016-0TP50	5	6SN112-1AA00-0AA1

Options (last 3 digits of the Order No.)

A Incremental encoder sin/cos, 1Vpp
 E Absolute value encoder (EnDat)
 G Basic absolute value encoder (EnDat)
 S Resolver, multi-pole

A with keyway, without holding brake
 B with keyway, with holding brake
 G no keyway, without holding brake
 H no keyway, with holding brake
 T Resolver, 2-pole

0 IP 64, without paint finish
 2 IP 65, without paint finish
 3 IP 64, with paint finish RAL 7016
 5 IP 65, with paint finish RAL 7016
 T Resolver, 2-pole

Benefits for many industry sectors

1FK7 servomotors are the ideal motor solution for:

- Packaging machines
- Standard machine tools
- Robots and handling equipment
- Textile machines
- Printing machines
- Woodworking, glass, ceramics and stone-finishing machines
- Press feeders
- High-bay racking units
- Logistic transport systems
- Special-purpose machines
- Plastic machines
- Paper machines





Would you like more information
about the new servomotors?

Simply go to

www.siemens.com/drivesolutions



Siemens AG

Automation and Drives

Motion Control Systems

P.O. Box 32 69, D-91050 Erlangen

www.siemens.com/drivesolutions